



Cover 2:
Penthouse Gold

Cover 1:
Jive Silver

Gold Trim

Blaise Collection

Colours represented are to be used as a guide only.
Please refer to manufacturers swatch for a more accurate colour match.

Please note that colour shadings can vary slightly from each roll of fabric.
We cannot guarantee a precise match to these samples or between cut lengths and upholstered goods.

foamflex™
Award Winning Seating Technology

10/12/2024

BLAISE COVER GUIDE: STANDARD BACK ONLY

Please use this guide when ordering the following pieces to clarify cover options.

Corner Group: LH2, COR, RH2

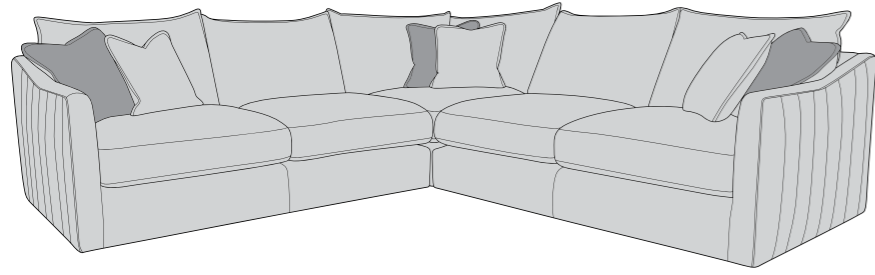

Corner Group: LH2, COR, RH1

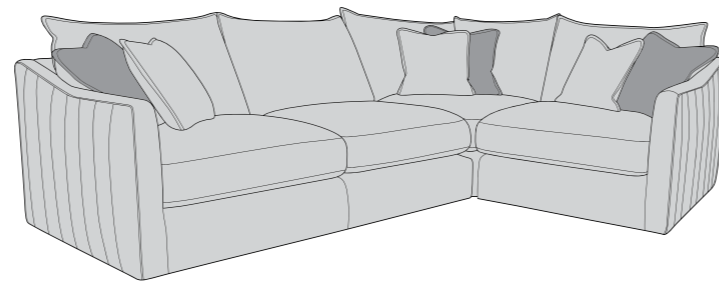

Corner Group: LH1, COR, RH2

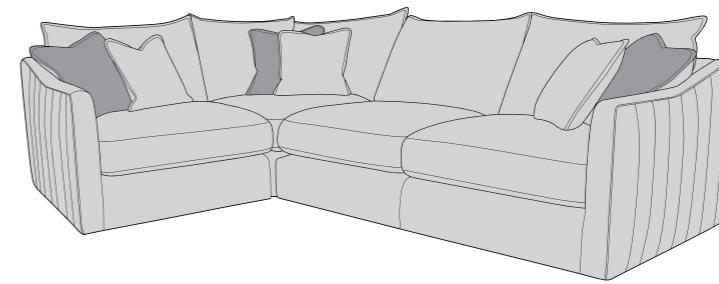

Corner Group: LH1, COR, RH1

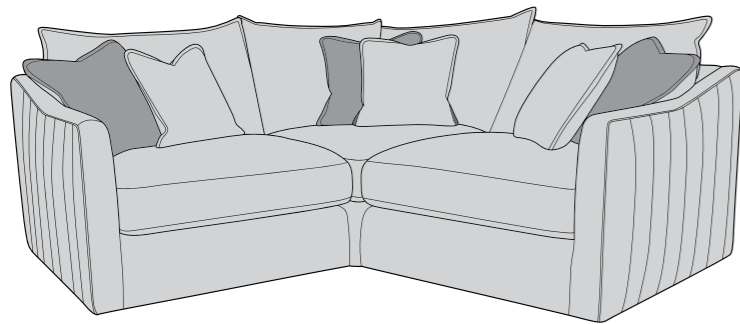

3 Seater Sofa (3ST)

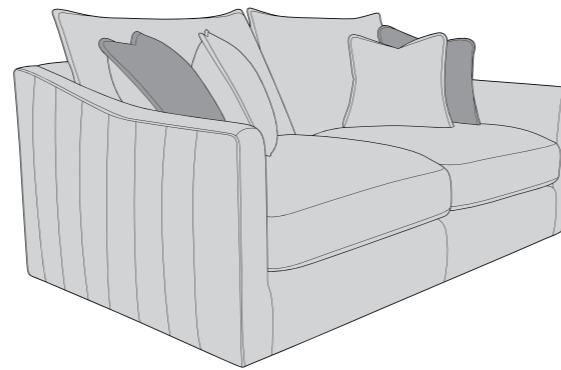

2 Seater Sofa (2ST)

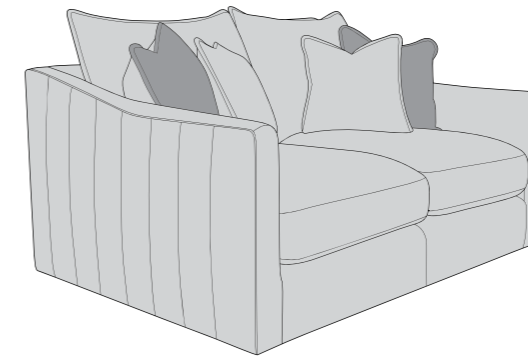

Arm Chair (1ST)

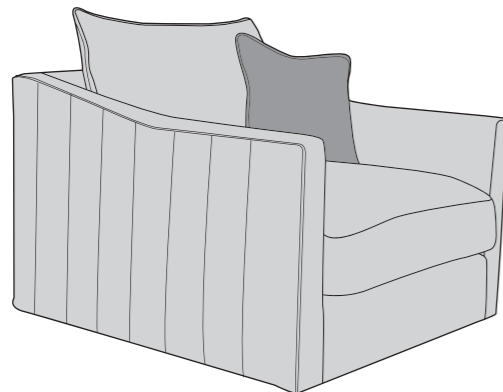

Armless Unit (ALU)

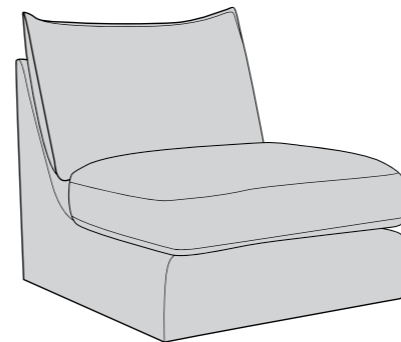

Blaise Large Footstool (FST)

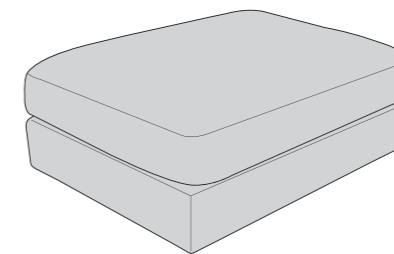

- COVER 1**
(BODY & SMALL SCATTERS)
- COVER 2**
(MEDIUM SCATTERS, SMALL ON CHAIR)

Scatter Cushions
Medium Scatters
(small on chair)

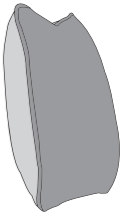

Flanged Edge
Front = Cover 2
Back = Cover 1

Small Scatters

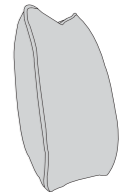

Flanged Edge
Front = Cover 1
Back = Cover 1



BLAISE DIMENSIONS (CM)

AVAILABLE PIECES	HEIGHT 1	OUTBACK HEIGHT	WIDTH 2	DEPTH 3	ARM HEIGHT	SEAT HEIGHT 4	SEAT DEPTH 5	SEAT WIDTH 6	ACCESS DIAGONAL 7	WEIGHT (KG)	SCATTER CUSHION NO.
LH2, COR, RH2 GROUP	88	70	272	272	60	47	N/A	N/A	N/A	140	6 (3 Medium, 3 Small)
LH2, COR, RH1 GROUP or LH1, COR, RH2 GROUP	88	70	272	195	60	47	N/A	N/A	N/A	124	6 (3 Medium, 3 Small)
LH1, COR, RH1 GROUP	88	70	195	195	60	47	N/A	N/A	N/A	108	6 (3 Medium, 3 Small)
LH2/RH2 UNIT	88	70	167	105	60	47	66	155	194	52	2 (1 Medium, 1 Small)
LH1/RH1 UNIT	88	70	90	105	60	47	66	N/A	N/A	36	2 (1 Medium, 1 Small)
COR - CORNER UNIT	88	70	105	105	N/A	47	66	N/A	145	36	2 (1 Medium, 1 Small)
ALU - ARMLESS UNIT	88	70	75	105	N/A	47	66	N/A	129	25	N/A
<hr/>											
3 SEATER SOFA (3ST)	88	70	176	105	60	47	66	151	200	63	4 (2 Medium, 2 Small)
2 SEATER SOFA (2ST)	88	70	155	105	60	47	66	130	183	56.5	4 (2 Medium, 2 Small)
ARM CHAIR (1ST)	88	70	100	105	60	47	66	75	140	44	1 Small
<hr/>											
ACCENT PIECES											
LARGE FOOTSTOOL P (FST)	47	N/A	105	78	N/A	N/A	N/A	N/A	128	18	N/A



* Hardwood & composite board frame.

* Dowelled, screwed, glued & stapled joinery.

* No trim or Black, Chrome or Gold available.

* Fibre filled reversible backs for added comfort.

* Feather filled scatters included. 

* Award winning foamflex seat interior.

* Serpentine seat springs & silent wire.

* Elasticated back webbing.

DIMENSION GUIDE

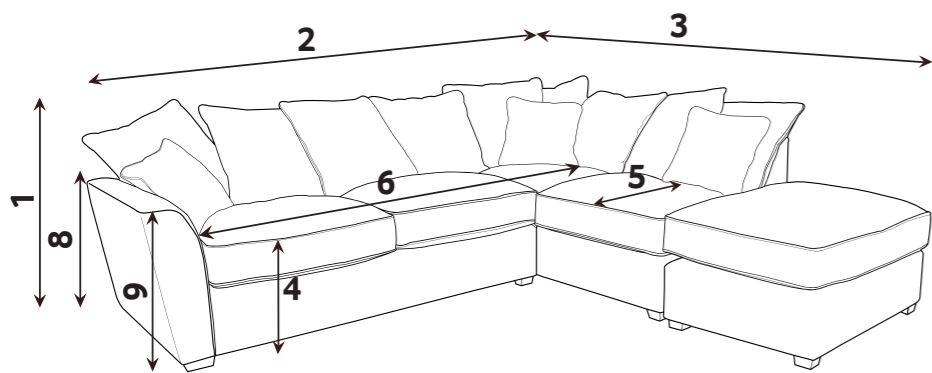

1 - HEIGHT
2 - WIDTH

3 - DEPTH
4 - SEAT HEIGHT
6 - SEAT WIDTH

5 - SEAT DEPTH (STD & PILLOW)
7 - DIAGONAL ACCESS

8 - OUTBACK HEIGHT
9 - ARM HEIGHT

Illustrations used for reference only.

Check the diagonal access dimension to ensure furniture will fit in your home.

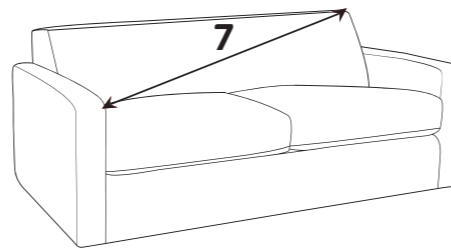

foamflex™

Our expertly engineered foam seat interior gives you the comfort of fibre with the retention of foam.

CARE GUIDE

To improve the longevity of your hand-made furniture, we recommend rotating cushions (where applicable).

For further information on maintaining your furniture, please refer to the Care Guide located under the seat platform.



Our foamflex seat interiors have been granted the FIRA GOLD Award, a mark of quality under-pinning all necessary testing of the product materials, design and production techniques.

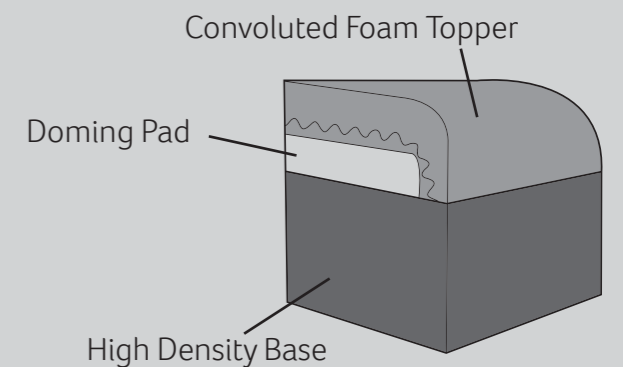

A choice of no trim or Black, Chrome or Gold is available except on accent pieces and armless unit.